

# Protected-Mode Address Translation

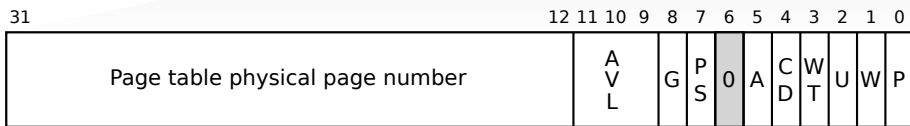

PDE

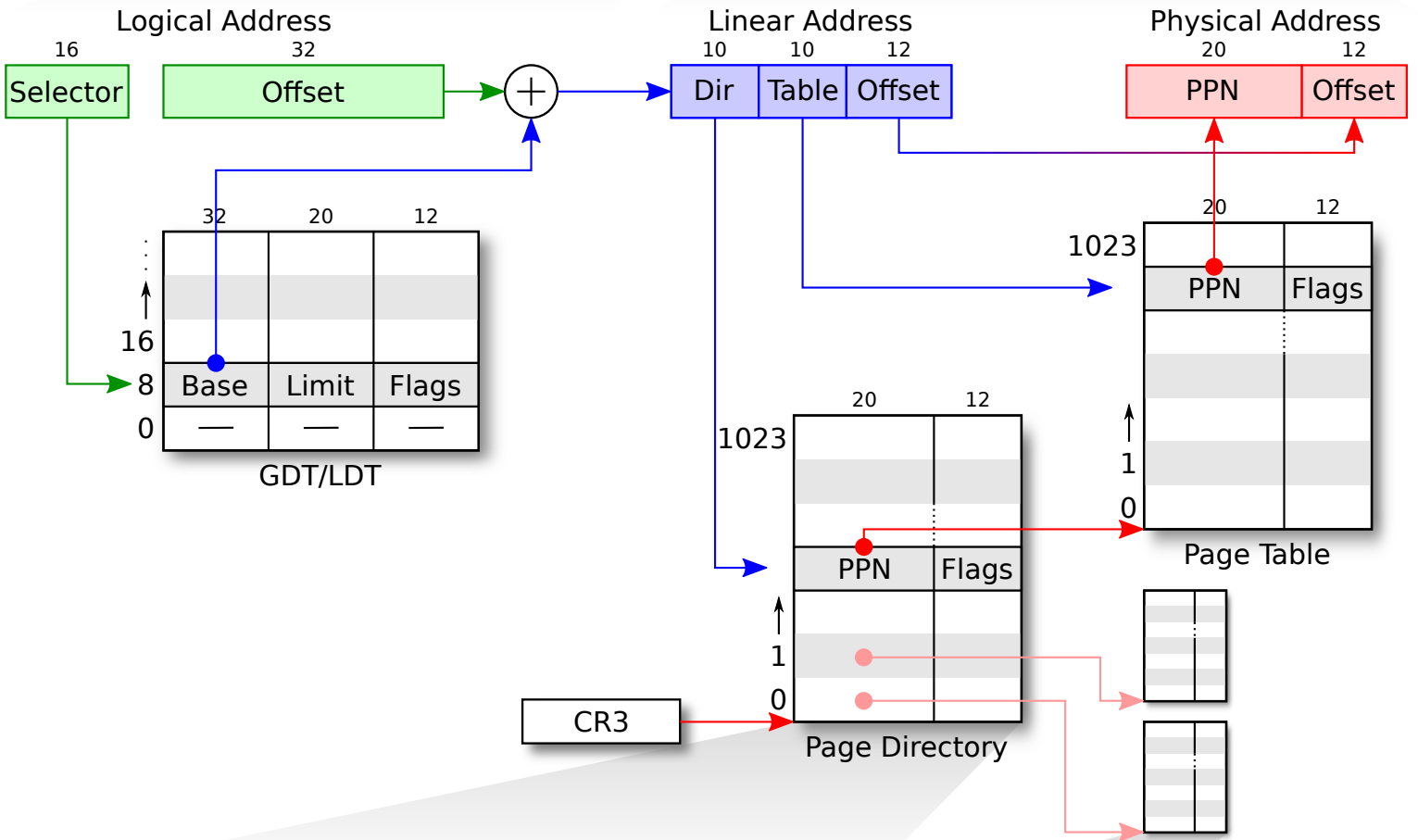
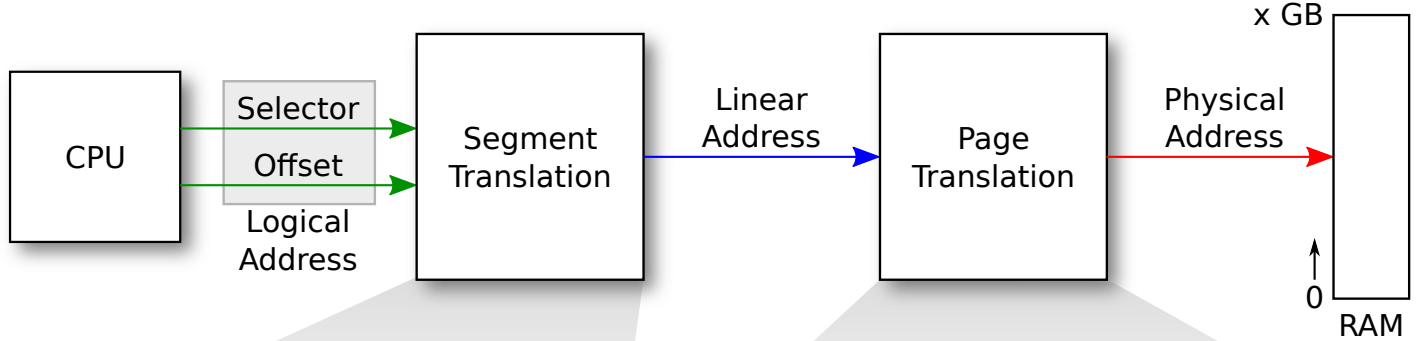
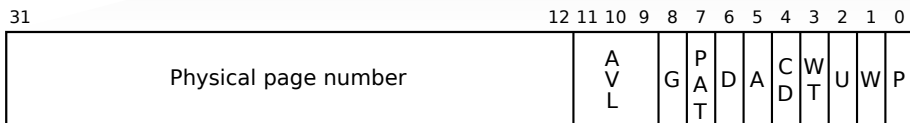

PTE

- P Present
- W Writable
- U User
- WT 1=Write-through, 0=Write-back
- CD Cache disabled
- A Accessed
- D Dirty
- PS Page size (0=4KB, 1=4MB)
- PAT Page table attribute index
- G Global page
- AVL Available for system use

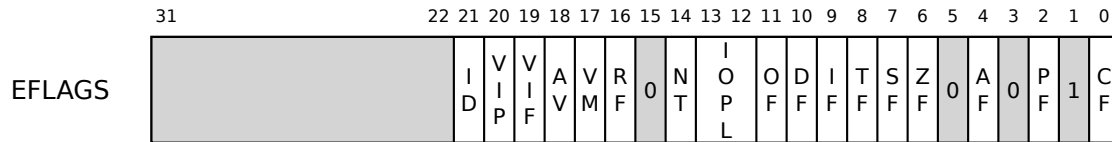

- |                         |                          |     |                       |
|-------------------------|--------------------------|-----|-----------------------|
| Status flags            | Control flags            | RF  | Resume flag           |
| CF Carry flag           | DF Direction flag        | VM  | Virtual-8086 mode     |
| PF Parity flag          | System flags             | AC  | Alignment check       |
| AF Auxiliary carry flag | TF Trap flag             | VIF | Virtual intr. flag    |
| ZF Zero flag            | IF Interrupt enable flag | VIP | Virtual intr. pending |
| SF Sign flag            | IOPL I/O privilege level | ID  | ID flag               |
| OF Overflow flag        | NT Nested task           |     |                       |

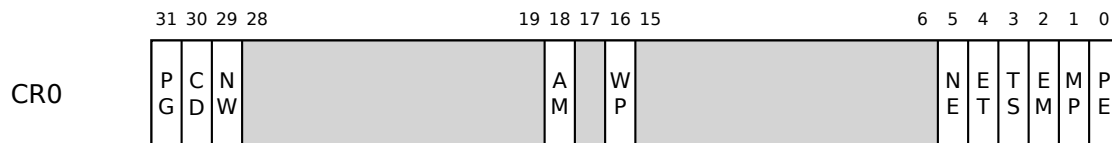

- |    |                     |    |                |    |                   |
|----|---------------------|----|----------------|----|-------------------|
| PE | Protection enabled  | ET | Extension type | NW | Not write-through |
| MP | Monitor coprocessor | NE | Numeric error  | CD | Cache disable     |
| EM | Emulation           | WP | Write protect  | PG | Paging            |
| TS | Task switched       | AM | Alignment mask |    |                   |

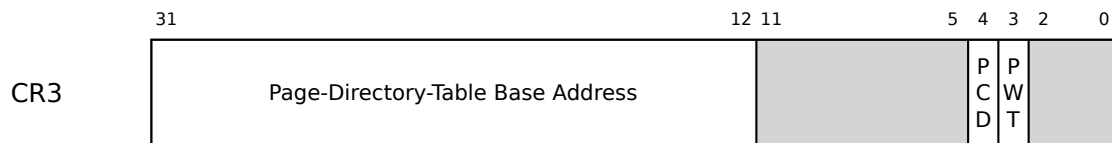
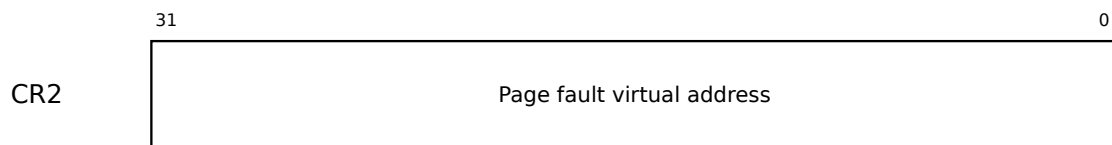

- |     |                               |     |                          |
|-----|-------------------------------|-----|--------------------------|
| PWT | Page-level writes transparent | PCT | Page-level cache disable |
|-----|-------------------------------|-----|--------------------------|



- |     |                                   |        |                               |
|-----|-----------------------------------|--------|-------------------------------|
| VME | Virtual-8086 mode extensions      | MCE    | Machine check enable          |
| PVI | Protected-mode virtual interrupts | PGE    | Page-global enable            |
| TSD | Time stamp disable                | PCE    | Performance counter enable    |
| DE  | Debugging extensions              | OSFXSR | OS FXSAVE/FXRSTOR support     |
| PSE | Page size extensions              | OSXMM- | OS unmasked exception support |
| PAE | Physical-address extension        | EXCPT  |                               |

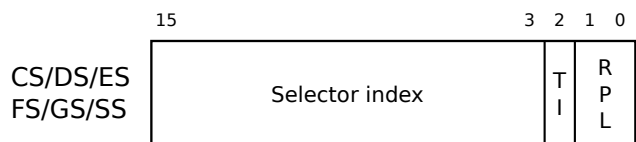

- |     |                            |
|-----|----------------------------|
| TI  | Table index (0=GDT, 1=LDT) |
| RPL | Requester privilege level  |